

# CROQUIS PERFILES

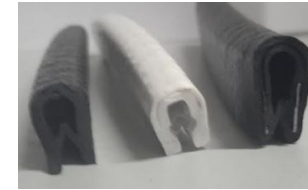

## Perfiles Armados

Ref: 401

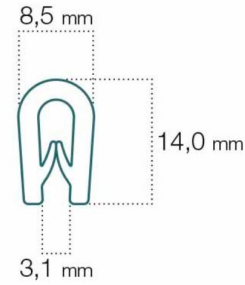

Ref: 402

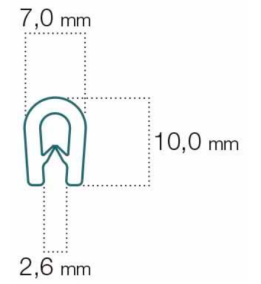

Ref: 412

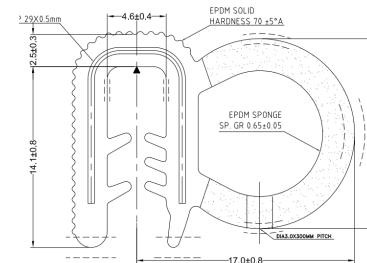

Ref: 411

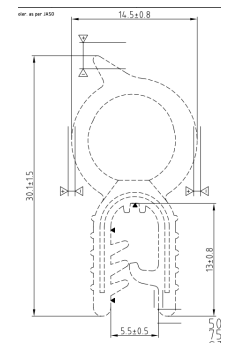

Ref: 401 G

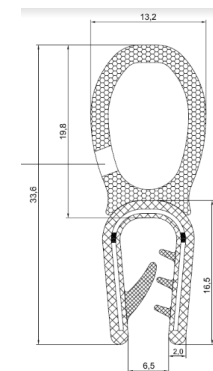
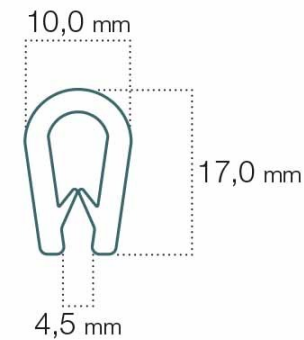

Ref: 411GA

Ref: 412 G

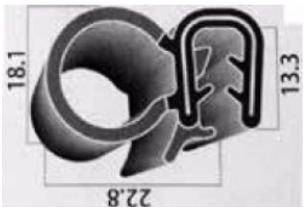

Ref: 412 GA

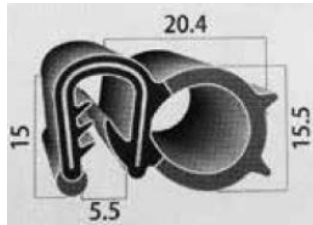

Ref: 411 G



### Perfiles en caucho y silicona Forma U

Ref: 07

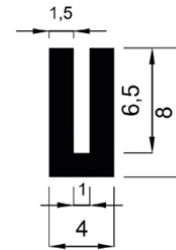

Ref: 04



Ref: 05 goma y silicona

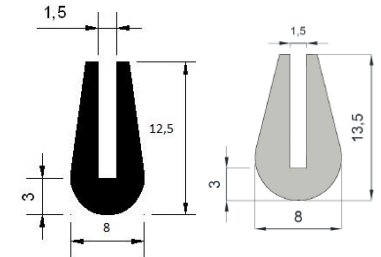

Ref: 412 P

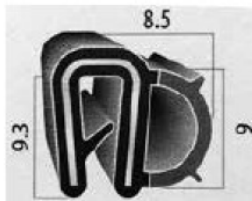

Ref: 411 P



Ref: 411 PA

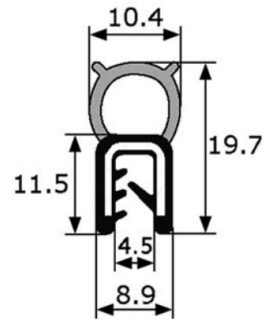

Ref: 10

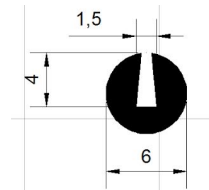

Ref: 8,5

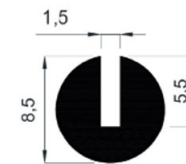

Ref: 12

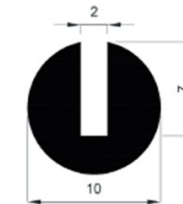

Ref: 12 SIL

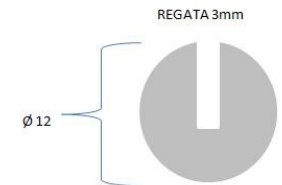

Ref: 401 c/ALA

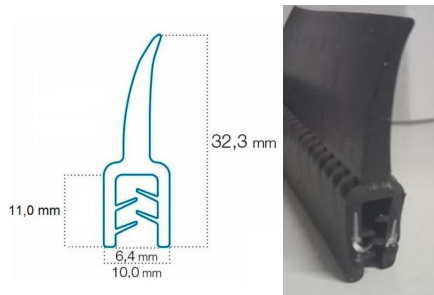

Ref: C/FELPA

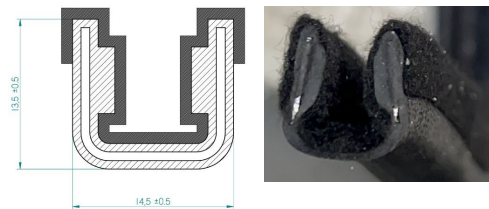

Ref: 06



Ref: 08



Ref: 11

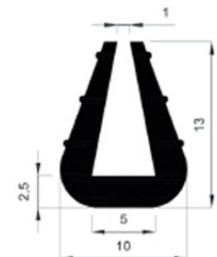

**Se pueden hacer perfiles a partir de croquis y cantidades mínimas**

Ref: 4,5

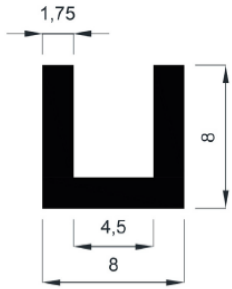

Ref: 10 x 12,5

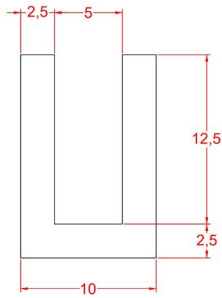

Ref: 16

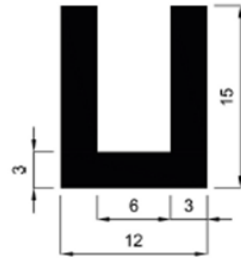

Ref: 20

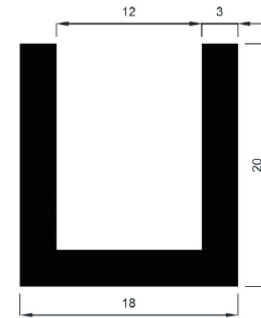

Ref: 107

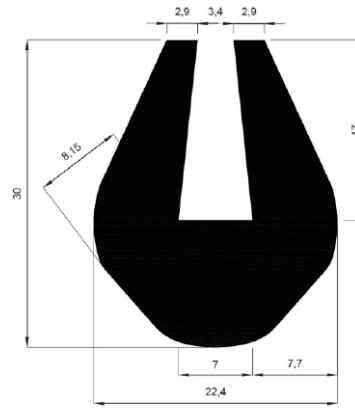

Ref: R20

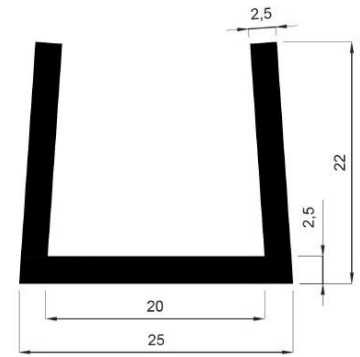

Ref: 1/2

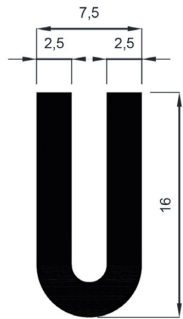

Ref: 09



Ref: 17

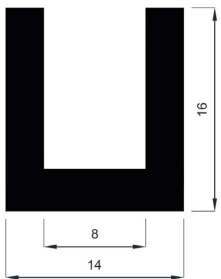

Ref: 03

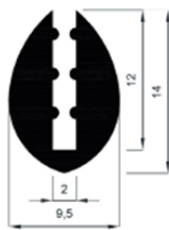

Ref: 24



Ref: FORMA 5

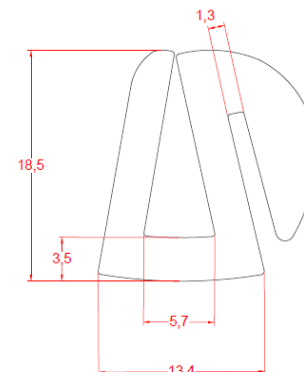

Ref: 08 G

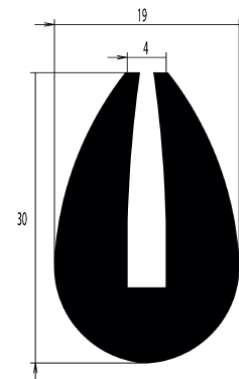

**Se pueden hacer perfiles a partir de croquis; y cantidades mínimas**

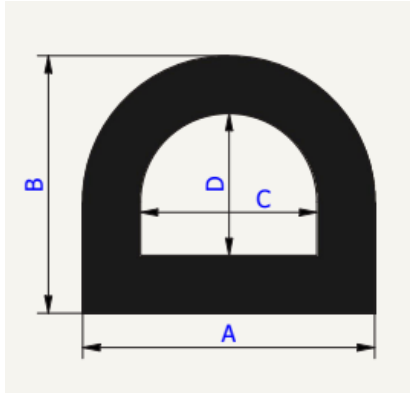

Perfil DEFENSA FORMA D

A 50 X B 60  
A 80 X B 70

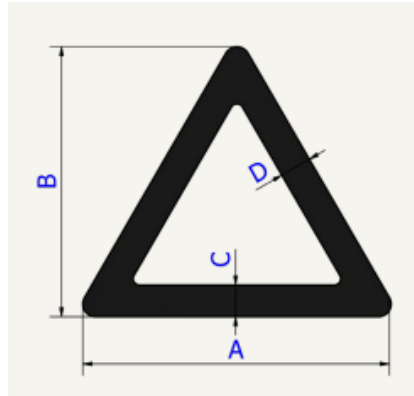

Perfil DEFENSA FORMA TRIANGULAR

A 80 X B 70  
A 110 X B 95

TIRAS DE 1 METROS + LARGO BAJO  
FABRICACIÓN ( excepción de que haya fabricado.



Perfil en caucho esponjoso Ref: 01



Perfil caucho esponjoso  
Media caña 20 x 12

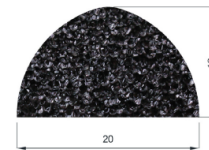

Perfil caucho esponjoso  
Media caña 9 X 6 c/adh.

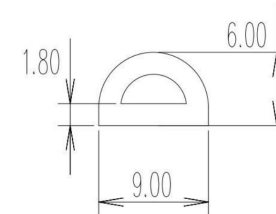

Perfil en caucho esponjoso Ø 12

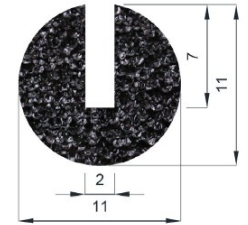

Perfil caucho esponjoso  
Media caña 9 X 9

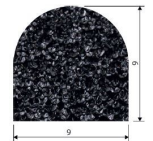

Perfil de caucho esponjoso  
ref: Omega

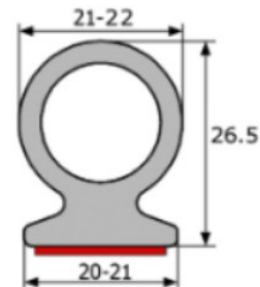

Perfil en PVC altura 8mm  
regata 1,5—2mm

Ref: 01 adh  
( Negro, Gris, transparente )



Perfil en PVC altura 6mm  
regata 1mm  
Ref: O2



Perfil en caucho EPDM Ref: 21



Perfil en caucho EPDM Ref: 15 limpia



Perfil en caucho EPDM Ref: 14/2

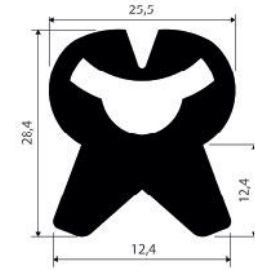

Perfil en caucho EPDM  
Ref: 105 + junquillo

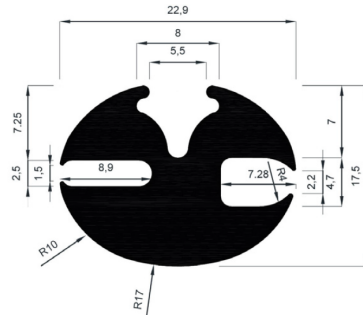
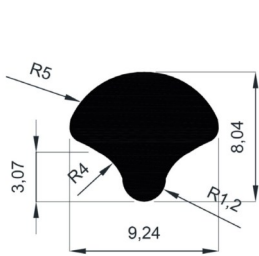

Perfil en caucho EPDM Ref: 30 x 18,16

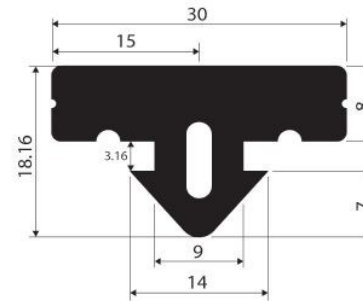

Perfil en caucho EPDM REF: CB -65

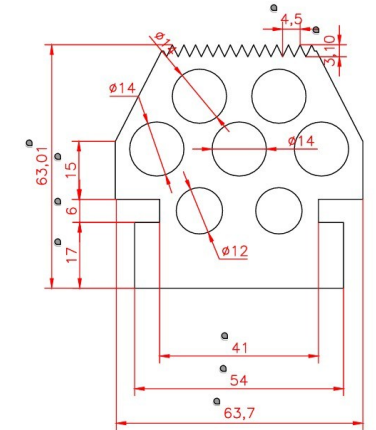

Perfil en caucho EPDM  
Ref: Forma H

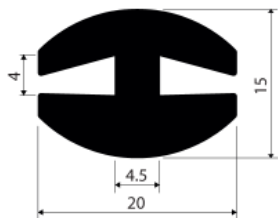

Perfil en caucho EPDM  
Ref: 18 Abrazadera



Perfil en caucho EPDM Ref: 14

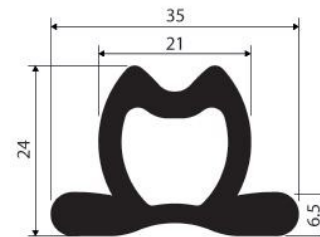

Perfil en silicona Ref: 12x12D

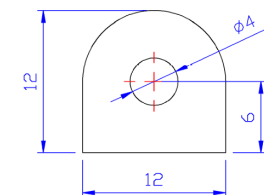

Perfil en silicona gris y caucho EPDM negro  
FORMA e

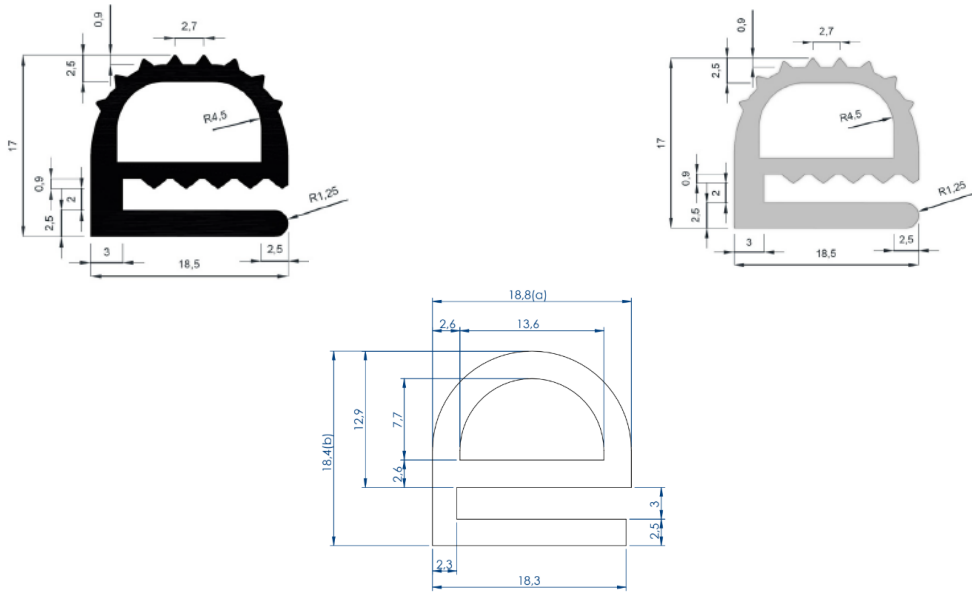

Perfil goma para escalera

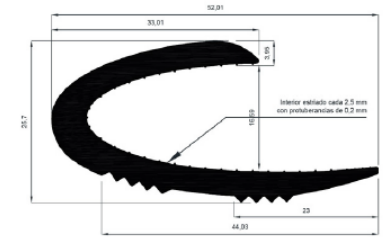
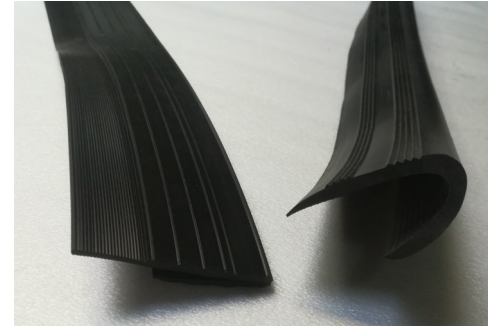

Perfil en caucho EPDM FORMA T

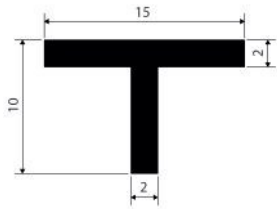

Perfil en caucho EPDM Ref: 19 forma 9

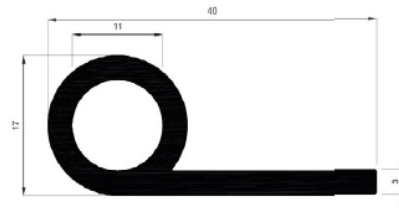

Perfil en caucho EPDM Blanco  
Ref: 110

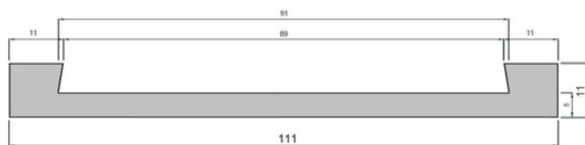

**Se pueden hacer perfiles a partir de croquis y cantidades mínimas**

Perfil goma forma L 20 x 20

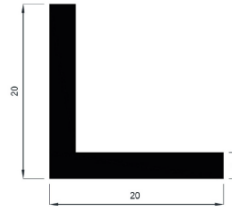

Perfil goma forma L 30 x 30

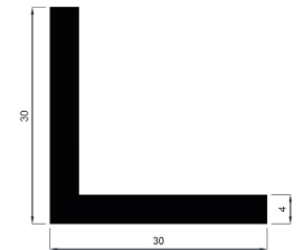

Perfil goma forma L 40 x 40

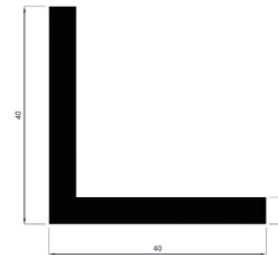

Perfil goma forma L 70 x 70

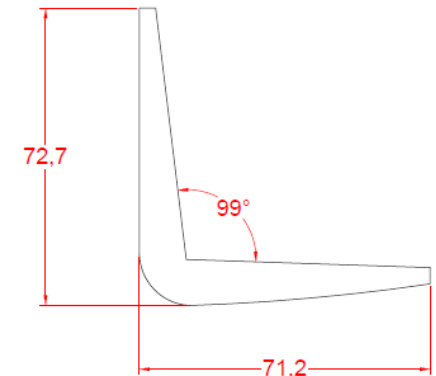

Perfil goma esponjosa forma L

L 40 x 40 y L 60 x 60

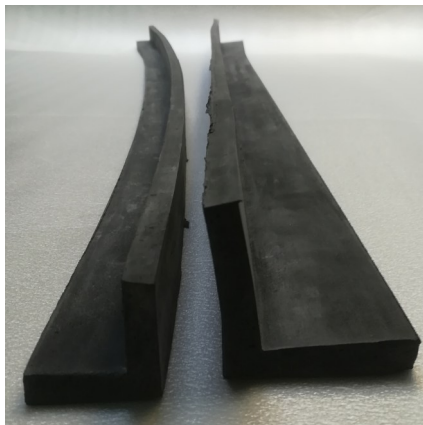

Perfiles para acristalar  
Hueco de 1-2mm y de 3-4mm



Perfiles para acristalar hay para más huecos pero  
estos son los estándar